



VOLspeed

Ebike Tuning

Yamaha PW-X / PW-X2 / PW-SE /
PW-ST / PW-TE

Operating Manual Installation Guide





Attention!

Read these instructions completely before using the device, keep the instructions and pass them on when handing over the device to other persons.

Product Features

The device offers the following functions after installation in eBikes with PW-X, PW-X2, PW-SE, PW-ST and PW-TE drive system (25km/h):

- Speed limit adjustable from 25 to 99 km/h via handlebar control buttons
- Adjustable dynamic mode with reduced "wall effect"
- Correct display of speed and distance
- Range calculation taking into account the current driving style
- Correct total distance after removal of the tuning module
- Wheel circumference adjustable with handlebar control buttons

All settings are made via the operating unit on the eBike. No smartphone or notebook is required.

The module is internally protected from splash water by a protective coating of the entire electronics.

Intended Use

The device is only suitable for installation in eBikes with Yamaha PW-X, PW-X2, PW-SE, PW-ST or PW-TE drive systems and displays A, C or X.

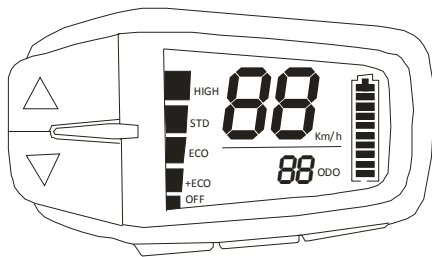

Display A (Sideswitch)

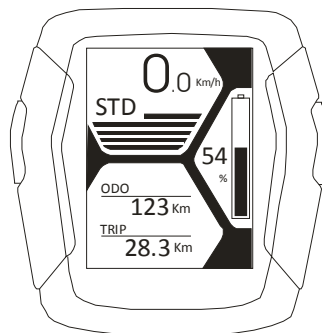

Display C (Multiswitch)

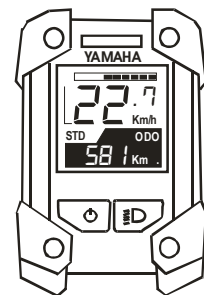

Display X



Legal and Safety Notes / Product Liability

- **Operation of the eBike in public traffic is no longer permitted after installation of the module. The use is only allowed on private areas or designated test and race tracks.**
- **Damage caused in conjunction with the operation of the eBike will no longer be covered by private liability insurance after installation.**
- **Liability and warranty claims against the dealer or manufacturer of the eBike expire or are constricted.**
- **The eBike is subject to higher mechanical stress when operating at higher speed for which it is not designed. This results in additional safety risks.**
- **The installation and operation of the module is at your own risk. The manufacturer accepts no liability for damage that is connected with the operation of the device.**
- **Please inform yourself about possible further technical and legal consequences before installing the device.**

Technical Data

Housing dimensions:	43mm x 22mm x 11mm
Cable length:	approx. 140mm
Weight:	0,025kg
Power consumption:	0,2W
Supply voltage:	12VDC

Installation PW-SE (Example: Haibike SDURO FullSeven 6.0)

Required tools:

- Allen key 6mm
- Allen key 3mm
- Torque ratchet with Allen key 6mm

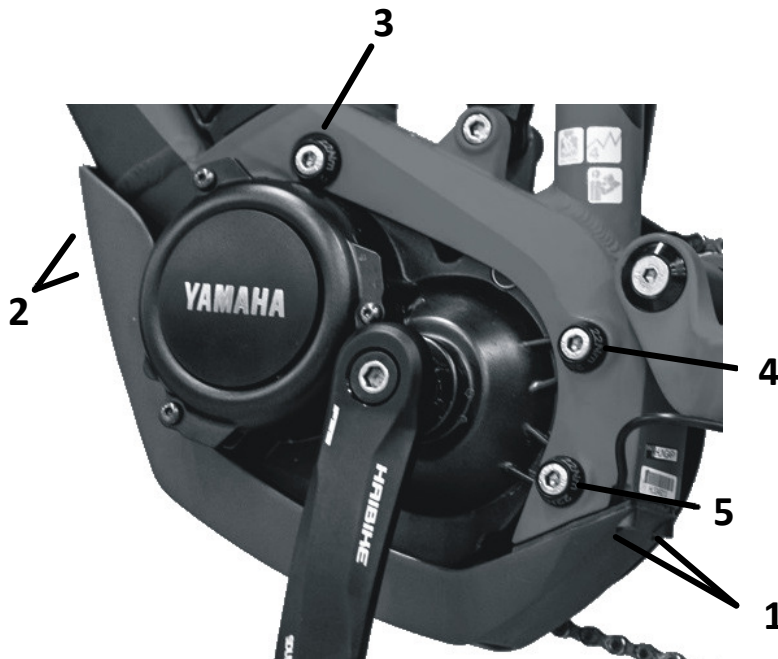

Procedure:

1. Remove battery
2. Remove the skid plate by removing the 4 screws (1) and (2). The screws behind the chainring do not need to be removed.
3. Loosen the screws (3), (4) and (5) of the motor.
4. Remove the screws (3) and (4) and fold down the motor.
5. Disconnect the cable to the speed sensor (3-wire) and cable to the LCD (4-wire).

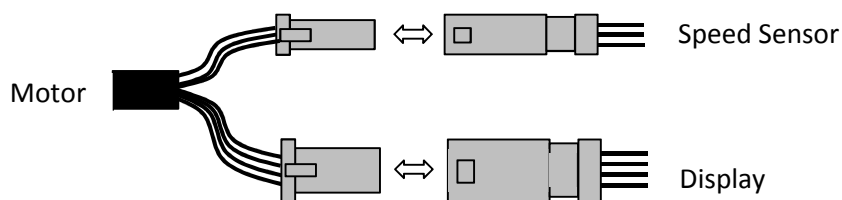



6. Plug in the tuning module as shown.

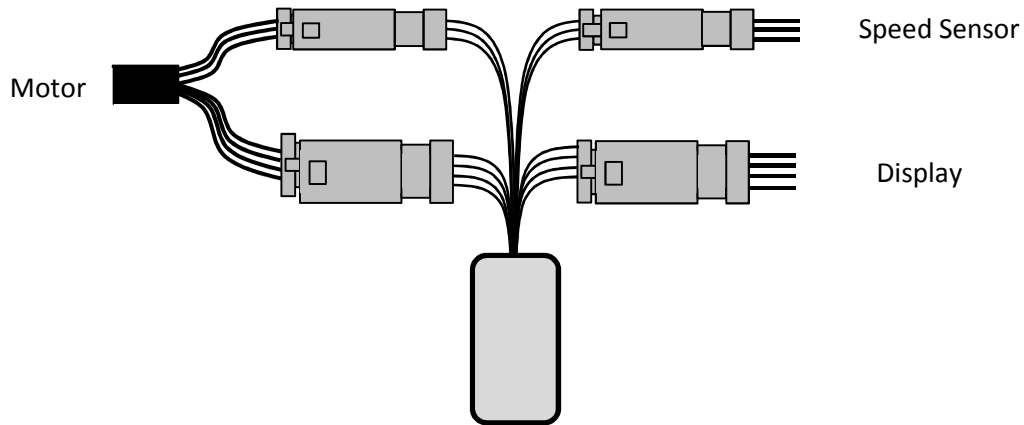

7. Insert the battery and carry out the initialization, see separate point setup.
8. If setup succeeds, remove the battery again.
9. Place the tuning module in a suitable location and route the cable so that the engine can be folded up without squeezing the cables.



Due to the large number of different drive systems, it is not possible to define a fixed installation location. Often a placement of the module in the down tube is possible.

10. Fold up the engine and reassemble the screws (3) and (4). Do not squeeze any cables.



In the case of full suspension bikes, make sure that the cable to the speed sensor at the transition to the rear triangle has enough room to move, otherwise it may break off during compression.

11. Tighten screws (3), (4) and (5) to 22Nm.
12. Fasten skid plate with screws (1) and (2).

Installation PW-X (Example: Haibike SDURO FullSeven 10.0)

The fixing screw of the PW-X motor marked with (6) is not directly accessible. In the following description, therefore, the chainrings are dismantled. It may also be possible to disassemble the screw with a 5mm Allen wrench with short leg or through a recess in the chainring.

Required tools:

- Allen key 3, 5 and 6mm
- Chainring nut wrench
- Torque ratchet with Allen key 4 and 6mm
- Threadlocker medium or high strength

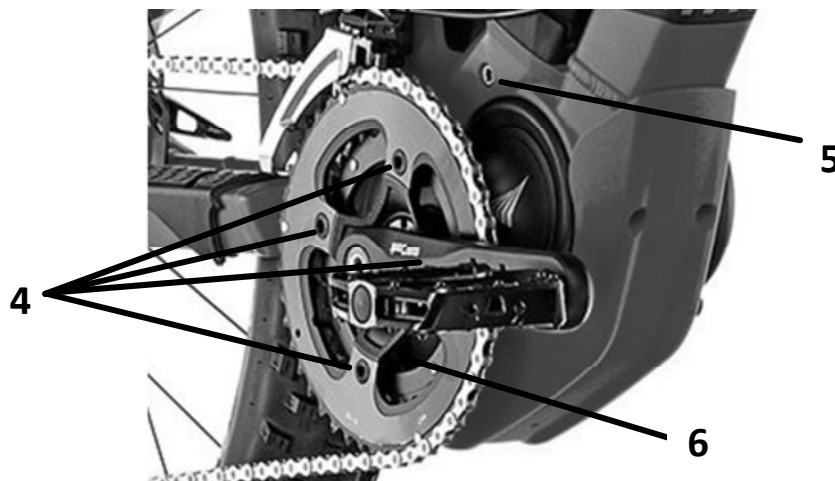



Procedure:

1. Remove battery
2. Remove the skid plate by removing the 4 screws (1) and (2).
3. Remove the chain from the chain ring and let it hang on the front derailleur.
4. Remove the chainring retaining bolts (4) and remove the chainrings. If necessary, use a nut wrench to counter.
5. Place a box or something similar under the drive unit to be able to put it on after disassembly. The shelf should be about 20cm under the motor.
6. Remove the screws (5), (6) and afterwards (3). Hold the motor with one hand while removing the screws.
7. Place the drive unit on the shelf.
8. Connect the tuning module as described under "Installation PW-SE", points 5 and 6.
9. Insert the battery and carry out the initialization, see separate point setup.
10. If setup succeeds, remove the battery again.
11. Place the tuning module and as far as possible the connection cable in the front frame tube.
12. Put the drive unit back in the holder on the frame. Do not squeeze any cables.
13. Reassemble the screws (3), afterwards (5) and (6).
14. Tighten screws (3) to 22Nm, (5) and (6) to 11Nm.
15. Fasten skid plate with screws (1) and (2).
16. Reassemble the chainrings and insert screws (4) with threadlocker. Tighten to 11Nm.

Setup (until model year 2018)

Before the first use of the tuning module or after conversion to another bike the setup must always be carried out first. Even in the case of malfunctions, a defined state of the module can be restored by executing the setup.

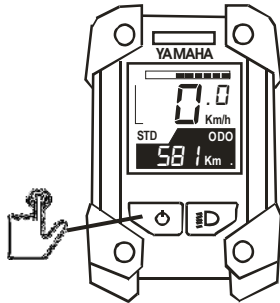

Turn on the eBike.

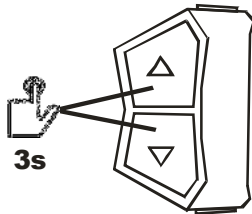

Press „arrow up“ and „arrow down“ at the same time for 3 seconds.

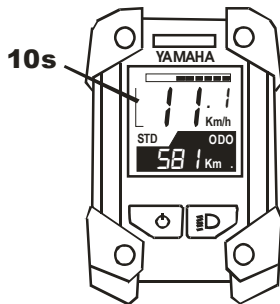

Speed 11.1 km/h is displayed for 10 seconds.

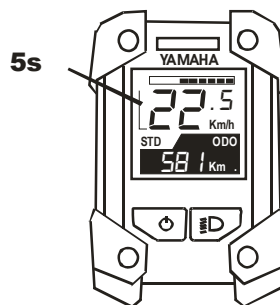

The wheel circumference stored in the drive unit is displayed for 5 seconds in centimeters. If necessary, adjust with the "arrow up" and "arrow down" buttons.

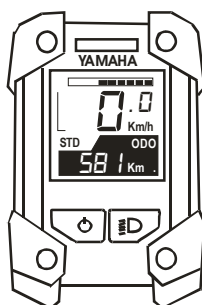

As soon as 0.0 km/h is displayed, the setup is finished.



Setup (from model year 2019)

Before the first use of the tuning module or after conversion to another bike the setup must always be carried out first. Even in the case of malfunctions, a defined state of the module can be restored by executing the setup.

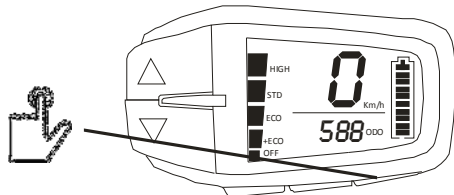

Turn on the eBike and switch to ODO or TRIP screen.

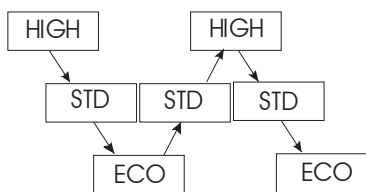

Change assistance level with „arrow up“ and „arrow down“ buttons as shown.

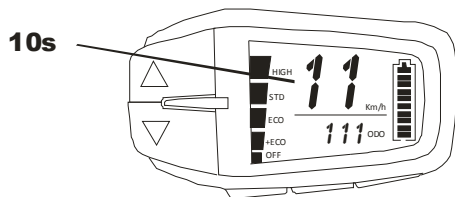

Speed 11.1 km/h is displayed for 10 seconds.

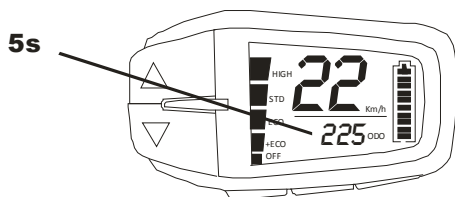

The wheel circumference stored in the drive unit is displayed for 5 seconds in centimeters.

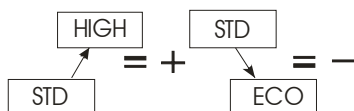

If necessary, adapt with „arrow up“ and „arrow down“ buttons as shown.

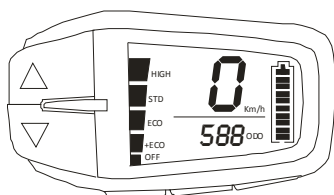

As soon as 0.0 km/h is displayed, the setup is finished.



Speed Mode (until model year 2018)

When speed mode is activated, the speed limit for the motor assistance is increased. The limit can be set from 25 to 99 km/h.

Turning off the eBike automatically turns off speed mode and must be reactivated after the bike is turned on.

Activation / adjust limit

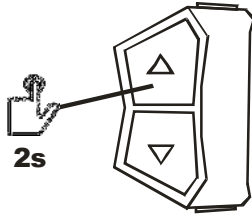

Press „arrow up“ for > 2 seconds.

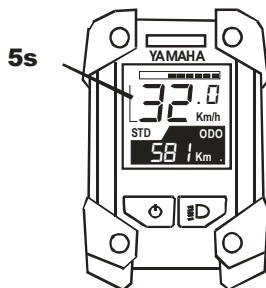

Speed limit is displayed for 5 seconds. If desired, use the "arrow up" and "arrow down" keys to change. Possible values: 25 to 99 km/h. Default value: 32 km/h.

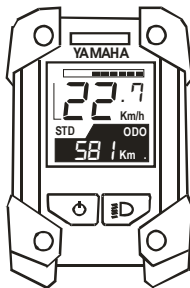

Display shows the normal driving speed again. Speed mode is active.

Deactivation

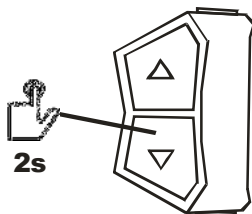

Press "down arrow" for > 2 seconds

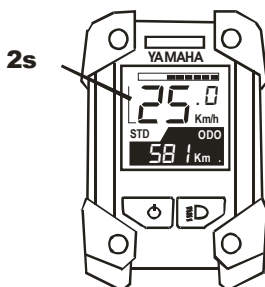

Display shows 25.0km/h for 2 seconds. Speed mode is off.



Speed Mode (from model year 2019)

When speed mode is activated, the speed limit for the motor assistance is increased. The limit can be set from 25 to 99 km/h.

Turning off the eBike automatically turns off speed mode and must be reactivated after the bike is turned on.

Activation / adjust limit

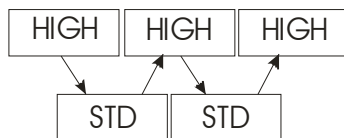

Change assistance level with „arrow up“ and „arrow down“ buttons as shown.

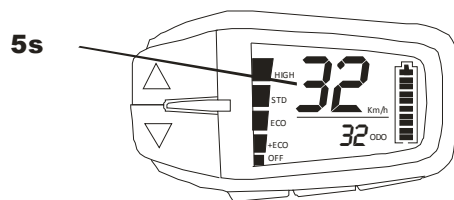

Speed limit is displayed for 5 seconds.

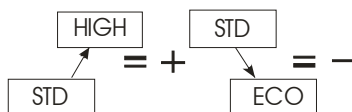

If necessary, adapt with „arrow up“ and „arrow down“ buttons as shown.

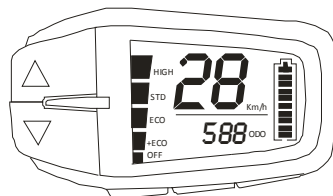

Display shows the normal driving speed again. Speed mode is active.

Deactivation

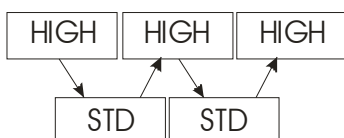

Change assistance level with „arrow up“ and „arrow down“ buttons as shown.

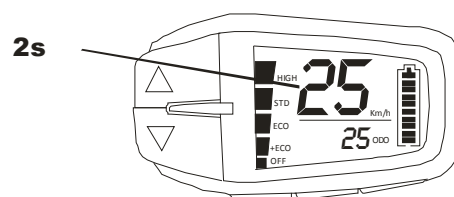

Display shows 25 km/h for 2 seconds. Speed mode is off.



Dynamic Mode (until model year 2018)

Exceeding the speed limit the motor power is reduced by default very much. A higher pedal force then results no longer in a higher speed, but in a lower motor assistance. For a more natural driving emotion in the dynamic mode the reduction is spread over a larger speed range, the so-called "wall effect" is significantly reduced and it can be driven with much more constant pedal force. The dynamic mode can only be activated when the speed mode is activated.

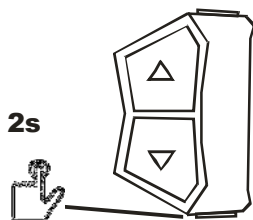
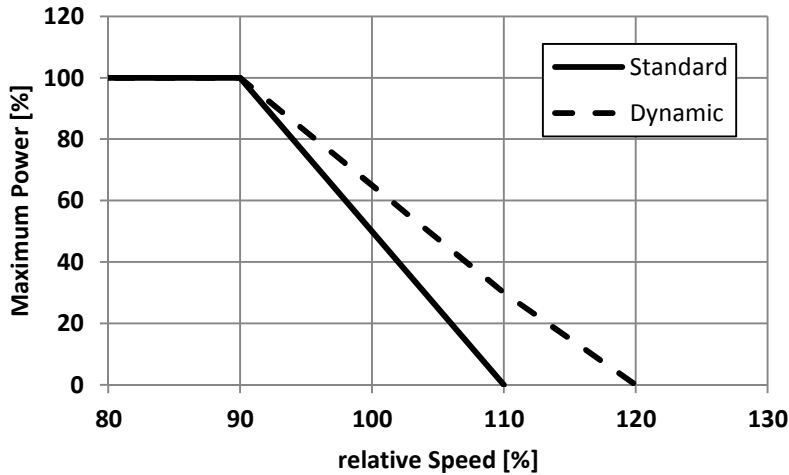

While driving (> 10km/h), press the pushing assist button for 2 seconds.

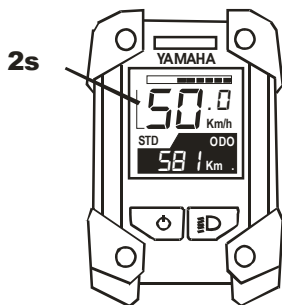

Dynamic mode off: 50.0 km/h is displayed for 2 seconds.

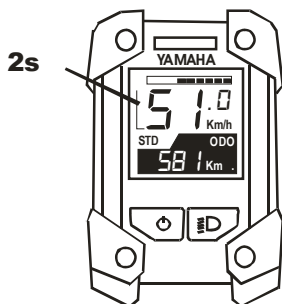

Dynamic mode on: 50.1 km/h is displayed for 2 seconds.



Dynamic Mode (from model year 2018)

Exceeding the speed limit the motor power is reduced by default very much. A higher pedal force then results no longer in a higher speed, but in a lower motor assistance. For a more natural driving emotion in the dynamic mode the reduction is spread over a larger speed range, the so-called "wall effect" is significantly reduced and it can be driven with much more constant pedal force. The dynamic mode can only be activated when the speed mode is activated.

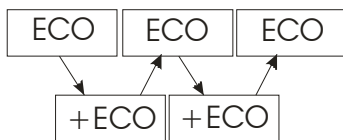
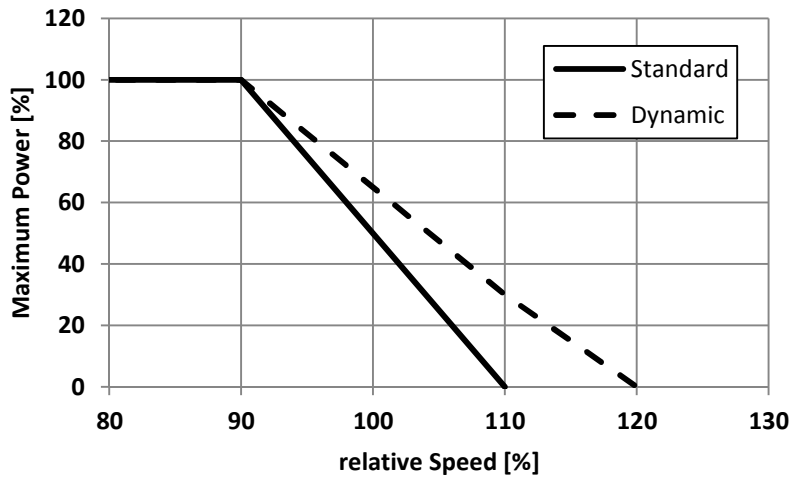

Change assistance level with „arrow up“ and „arrow down“ buttons as shown.

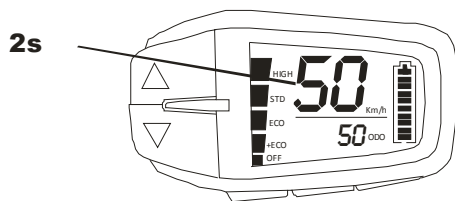

Dynamic mode off: 50 km/h is displayed for 2 seconds.

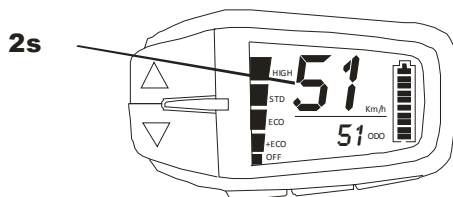

Dynamic mode on: 50.1 km/h is displayed for 2 seconds.



Range Calculation

The speed mode can significantly reduce the range of the eBike. In the original condition of the bike, the range is calculated only from the current battery charge level and the selected support level. When Speed Mode is activated, the current power consumption is additionally included in the range calculation, which makes the displayed remaining range more accurate.

Speed-Modus off

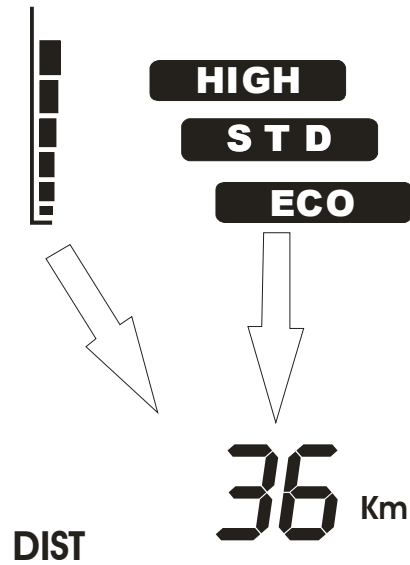

Speed Modus on

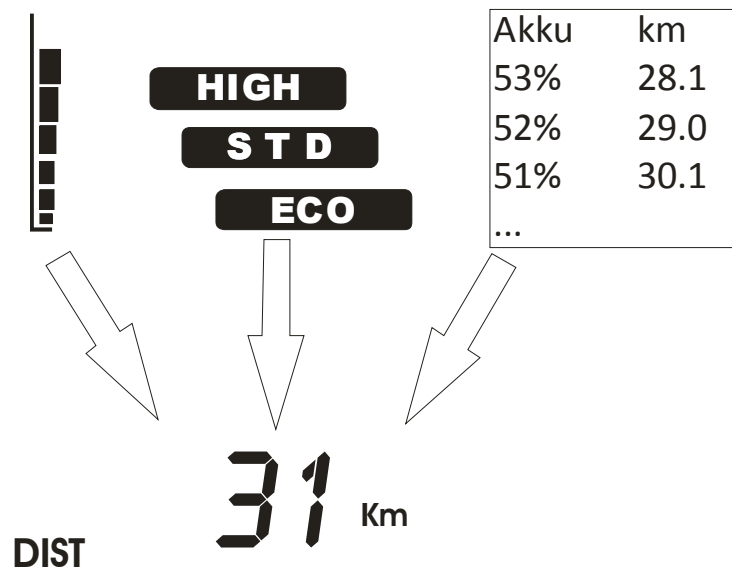



FAQ

Is the total mileage correct even after removing the module?

Yes. The total km measured by the drive unit are not changed by the tuning. This is ensured by a continuously working compensation function in the tuning module. However, before removing the module, the bike should remain switched on at standstill with the speed mode switched on until it shuts off by itself. This will ensure that the compensation function has correctly adjusted the mileage. However, any wheel circumference adjusted during the setup does not affect the mileage of the drive unit and there are deviations after removing the module.

The displayed distance (Odometer, Trip) or the speed is not correct. What can I do?

Run the setup again. As a result, the current mileage is taken over from the drive unit in the tuning module and you have the opportunity to re-adjust the wheel circumference if necessary.

Why can't the setup be activated?

The type of activation of the setup depends on the model year of the drive system. For older motors up to model year 2018, follow the description on page 8, otherwise the description on page 9. The displays shown are irrelevant for the selection of the procedure!

I adjusted the wheel circumference during setup. When I start the setup again, another value is displayed. Why?

When executing the setup, the original wheel circumference of the motor control is always displayed. If you want to use a different wheel circumference, you have to enter it again each time you run the setup.



Technical Support

For questions, suggestions or problems please email or phone.

TLI Elektronik GmbH

St.-Martin-Str. 11

86676 Ehekirchen

info@volspeed.de

phone: +49 (0) 8253 / 9279902

In addition to your request for support inquiries, please include the following information:

- Serial number and purchase number of the tuning module (S/N, P/N)
- eBike manufacturer, type and year of manufacture

To ensure that you always have the device data, you can enter it here before installing the device:

Purchase number (P/N): _____

Serial number (S/N): _____

Disposal

The tuning module should be disposed of in an environmentally correct manner.

For EC countries:



Electronic devices are valuable materials and do not belong in the household waste.

Dispose of the product at the end of its life in accordance with applicable legislation.